



ARCAM f·M·J

Pre Amplifier C31
Power Amplifier P35
Power Amplifier P1

Safety guidelines

	CAUTION RISK OF ELECTRIC SHOCK DO NOT OPEN	ATTENTION RISQUE DE CHOC ELECTRIQUE NE PAS OUVRIR	
<p>CAUTION: To reduce the risk of electric shock, do not remove cover (or back). No user serviceable parts inside. Refer servicing to qualified service personnel.</p> <p>WARNING: To reduce the risk of fire or electric shock, do not expose this apparatus to rain or moisture.</p> <p>The lightning flash with an arrowhead symbol within an equilateral triangle, is intended to alert the user to the presence of uninsulated 'dangerous voltage' within the product's enclosure that may be of sufficient magnitude to constitute a risk of electric shock to persons.</p> <p>The exclamation mark within an equilateral triangle is intended to alert the user to the presence of important operating and maintenance (servicing) instructions in the literature accompanying the product.</p> <p>CAUTION: In Canada and the USA, to prevent electric shock, match the wide blade of the plug to the wide slot in the socket and insert the plug fully into the socket.</p>			

Important safety instructions

These products are designed and manufactured to meet strict quality and safety standards. However, you should be aware of the following installation and operation precautions:

1. Take heed of warnings and instructions

You should read all the safety and operating instructions before operating these products. Retain this handbook for future reference and adhere to all warnings in the handbook or on the product itself.

2. Water and moisture

The presence of electricity near water can be dangerous. Do not use these appliances near water – next to a bathtub, washbowl, kitchen sink, in a wet basement or near a swimming pool, etc.

3. Object or liquid entry

Take care that objects do not fall and liquids are not spilled into the enclosure of a unit through any openings. Liquid-filled objects such as vases should not be placed on these products.

4. Ventilation

Do not place these units on a bed, sofa, rug or similar soft surface, or in an enclosed bookcase or cabinet, since ventilation may be impeded. We recommend a minimum distance of 50mm (2 inches) around the sides and top of the each unit to provide adequate ventilation.

5. Heat

Locate these products away from naked flames or heat producing equipment such as radiators, stoves or other appliances (including other amplifiers) that produce heat.

6. Climate

These products have been designed for use in moderate climates.

7. Racks and stands

Only use a rack or stand that is recommended for use with audio equipment. If the equipment is on a portable rack it should be moved with great care, to avoid overturning the combination.

8. Cleaning

Unplug a unit from the mains power supply before cleaning.

The cases should normally only require a wipe with a soft, damp, lint-free cloth. Do not use paint thinners or other chemical solvents for cleaning.

We do not advise the use of furniture cleaning sprays or polishes as they can cause indelible white marks if the unit is subsequently wiped with a damp cloth.

9. Power sources

Only connect an unit to a power supply of the type described in the operating instructions or as marked on the product itself.

The primary method of isolating these products from the mains supply is to remove the mains lead from the rear of the unit. These products must be installed in manner that makes this disconnection possible.

These are Class 1 devices and must be earthed.

10. Power-cord protection

Power-supply cords should be routed so that they are not likely to be walked on or pinched by items placed upon or against them. Pay particular attention to cords and plugs, and the point where they exit from the unit.

11. Grounding

Ensure that the grounding means of these products is not defeated.

12. Power lines

Locate any outdoor antenna/aerial away from power lines.

13. Non-use periods

When using the stand-by function, a small amount of current will continue to flow into the unit. Unplug the power cord of a unit from the outlet if it is to be left unused for a long period of time.

14. Abnormal smell

If an abnormal smell or smoke is detected from a unit, turn the power off immediately and unplug the unit from the wall outlet. Contact your dealer for further advice.

15. Servicing

You should not attempt to service these products beyond that described in this handbook. All other servicing should be referred to qualified service personnel.

16. Damage requiring service

These products should be serviced by qualified service personnel when:

- the power-supply cord or the plug has been damaged, or
- objects have fallen, or liquid has spilled into the appliance, or
- the appliance has been exposed to rain, or
- the appliance does not appear to operate normally or exhibits a marked change in performance, or
- the appliance has been dropped or the enclosure damaged.

Safety compliance

These products have been designed to meet the IEC 60065 international electrical safety standard.

Using this handbook

Thank you for buying this quality Arcam product.

This handbook covers the following items:

- C31 pre-amplifier;
- P35 power amplifier;
- P1 power amplifier.

This handbook is intended to give you all the information you need to install and use these products. The C31 is described first, followed by the P35 and the P1. Use of the CR-389 remote control supplied with the C31 is also described.

If your amplifiers have been installed and set-up by an authorised Arcam dealer, you may wish to go directly to the sections on how to use this equipment. Otherwise we recommend reading carefully the installation instructions for your products before proceeding.

Safety

Safety guidelines are set out on page 2 of this handbook.

Many of these items are common-sense precautions but, for your own safety and to ensure that you do not damage the unit, we recommend that you read them.

Contents

Safety guidelines.....	E-2
Important safety instructions.....	E-2
Safety compliance.....	E-2
Using this handbook	E-3
Safety	E-3
Installation: C31 pre-amplifier.....	E-4
Positioning the unit	E-4
Connecting to other equipment.....	E-4
Connecting to a power supply.....	E-5
Switching the C31 on	E-6
Changing the volume	E-6
Selecting an audio source	E-6
Using your C31 pre-amplifier	E-6
Recording an audio source	E-7
Listening using headphones	E-7
Product configuration	E-7
Configuring your C31 pre-amplifier	E-8
Introduction.....	E-8
Adjusting listening settings	E-8
Using the remote control	E-9
Installation: P35 and P1 power amplifiers	E-10
Positioning your power amplifier	E-10
Connecting to other equipment.....	E-10
Remote switching	E-11
Connecting loudspeakers	E-12
Connecting to a power supply.....	E-13
Using your power amplifier	E-14
Technical specifications	E-15
Remote-control codes	E-16
Troubleshooting	E-17
Guarantee	E-17
On-line registration	E-17

Environmental matters:

This handbook is printed in the U K on recycled paper, and is itself fully recyclable and biodegradable

The paper used is from the 'Revive' range of papers, manufactured in the U K by Robert Horne. In Revive, 75% of the paper is de-inked post-consumer waste, with the remaining 25% being mill broke and virgin fibre. The recycled pulps used in the production of this paper are a combination of Totally Chlorine Free (TCF) giving zero AOX and Elemental Chlorine Free (ECF) giving a resultant AOX level of less than 0.5Kg per 1000Kg of pulp

Installation: C31 pre-amplifier

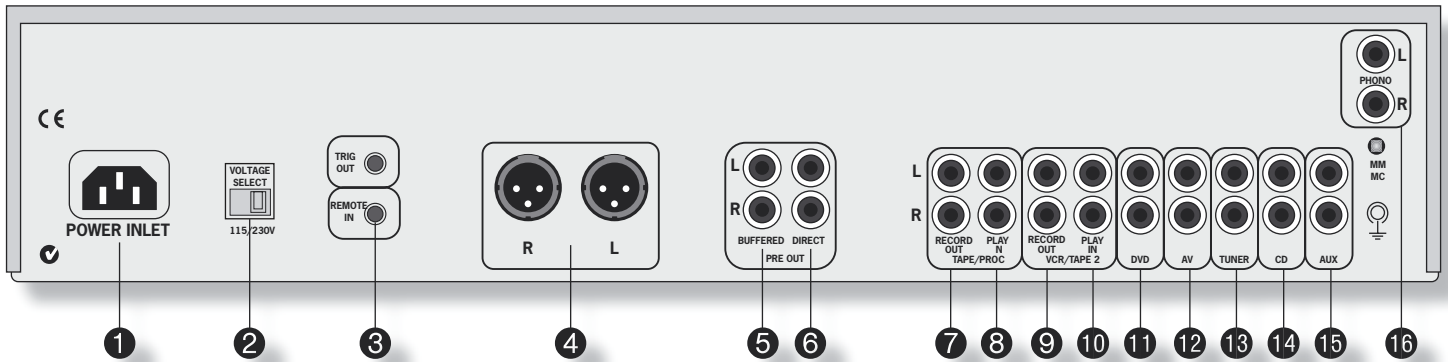

Positioning the unit

- Place your amplifier on a level, firm surface.
- Avoid placing the unit in direct sunlight or near sources of heat or damp.
- Ensure adequate ventilation. Do not place the unit in an enclosed space such as a bookcase or cabinet as both of these will impede air-flow through the unit.

Connecting to other equipment

The connections on the rear of the C31 fall into four groups:

1. dedicated audio inputs;
2. recording loops;
3. connections for power-amplifiers;
4. remote control and trigger connections.

These groups are described below.

General advice on connecting to other equipment

- We recommend the use of high-quality interconnect cables to and from your amplifier to ensure the best sound quality; cheap 'bell-wire' interconnects may seem to be a good alternative, but they will reduce the overall quality of your system, and are a false economy.
- Make sure that audio and power cables are kept as far apart from each other as possible. This reduces the risk of 'noise' from the power cables bleeding into those for audio.
- Cables should be kept as short as is practical.
- For each of the audio inputs/outputs that you wish to use, connect the terminal labelled **L** or **LEFT** (on the device to be connected) to the terminal labelled **L** for that input/output on the C31. Similarly, the terminal labelled **R** or **RIGHT** on the device should be connected to the **R**-terminal on the C31. Conventionally, stereo-phono leads have plugs that are coloured red for the right channel and white or black for the left channel, to aid channel identification.

Audio inputs

- 11 **DVD** – This input is intended for use with a DVD-player. Connect the stereo audio outputs of your DVD player to these sockets.
- 12 **AV** – This input is intended for use with general audio-visual equipment, such as a VCR, digital TV/satellite receiver, or Nicam tuner. Connect the analogue audio outputs of the device to this input.
- 13 **TUNER** – Intended for use with a radio tuner.
- 14 **CD** – Intended for use with a CD-player.
- 15 **AUX** – As with the 'AV' input, this is intended for general use. Connect the audio outputs of any unit with a line-level output (tape deck, tuner, etc.), to this input.
- 16 **PHONO** (if fitted) – As standard, no phono input is fitted to the C31. Phono inputs are provided on a separate plug-in module which your Arcam dealer or distributor can supply and fit. This module is compatible with most high-output moving-coil and moving-magnet cartridges (MM) and low-output moving-coil cartridges (MC). Once the module is fitted, MM or MC is selected via the **MM/MC** back panel switch.

Why is this useful?

The phono module (or an external phono amplifier) is required if you wish to connect a record player to the C31. This is because the low-voltage output of a record player requires a pre-amplification stage before the signal can be used.

If you have already an external phono amplifier that you wish to use, connect this to one of the line-level inputs, such as the 'AV' input.



With the exception of the 'PHONO' input, although these inputs are labelled for specific devices, all have the same characteristics and each may be used with any line-level product

Recording loops

The C31 is equipped with two recording loops, for use with recording devices (such as cassette decks, MiniDisc players, VCR's etc.)

- ⑦ **TAPE/PROC RECORD OUT** – Connect these output sockets to the input sockets of your recording device (usually labelled **RECORD** or **IN**).
- ⑧ **TAPE/PROC PLAY IN** – Connect the output sockets of your recording device (usually labelled **PLAY** or **OUT**) to these inputs.
If you do not have a recording device, you can use this input for other (line-level) equipment, such as a CD-player, tuner, VCR, etc.
- ⑨ **VCR/TAPE2 RECORD OUT** – These output sockets can be connected to the input sockets of a second recording device.
- ⑩ **VCR/TAPE2 PLAY IN** – Connect the output sockets of your second recording device to these inputs. Alternatively, this input may be used for other (line-level) equipment such as a CD-player, tuner, etc.

Power-amplifier connections

④ ⑤ ⑥ **PRE OUT** – The recommended connection between the C31 pre-amplifier and your power amplifier depends on both the distance between the two and the type of power amplifier that you are using. There are three options:

1. If the cables to be used to connect the C31 to the power amplifier are less than 3m long, we recommend connecting the **DIRECT** sockets ⑥ to the input sockets of your power amplifier. On the P35 and P1, connect to the socket(s) labelled **AUDIO IN**.

If the cables to be used to connect the C31 to the power amplifier are 3m or longer, then the connection to use depends on the type of power amplifier you have.

2. If your power amplifier does not have balanced inputs (such as the P35), use the **BUFFERED** outputs ⑤. On the P35, connect to the sockets labelled **AUDIO IN**.
3. If your power amplifier provides balanced inputs (such as the P1), use the balanced outputs ④. On the P1, connect to the sockets labelled **BALANCED AUDIO IN**.

The buffered and balanced outputs are designed to drive longer cables than the direct output, but you cannot damage either your C31 or your power amp. by using the "wrong" connection type.

Other connections

Phono earth terminal – For connecting your turntable earth lead (if required). Note that this terminal must not be used as a safety earth.

- ③ **TRIG OUT** and **REMOTE IN** (12V in and out) – These connections are intended for use in multi-room installations.

- **TRIG OUT:** This output provides a 12V signal whenever the unit is switched on (i.e., not off or in stand-by). This signal can be used to switch on power amplifiers (or other equipment) connected to the C31, as they will come on when the C31 is activated. This is useful if the power amplifier is remote from the C31, or otherwise difficult to access.

- **REMOTE IN:** This allows remote-control signals to be received by the C31 if the remote sensor is covered (or otherwise not 'visible' to the remote-control). An external sensor (such as the Xantech 'Dinky Link™') is used to receive the signals from the remote-control, which are then fed to the C31 (into this input) using a suitable cable.

In normal use there is no need to make any connections to either of these sockets.



The 12V-trigger uses a 3.5mm mono jack plug, wired as follows:

- Sleeve: Ground

- Tip: Active

When the C31 is powered-on, the tip carries 12V, current-limited to 30mA; otherwise the tip carries 0V

The remote-in also uses a 3.5mm mono jack plug, wired as above. Remote control signals must be in modulated RC5 format, with a voltage level of 5–15V. Note that the remote receiver will require its own power-supply.

Details of the Xantech 'Dinky Link' can be found at www.xantech.com, or ask your dealer

Connecting to a power supply

Mains lead

The appliance is normally supplied with a moulded mains plug already fitted to the lead. Check that the plug fits your supply and that your mains supply voltage agrees with the voltage setting (115V or 230V) indicated on the rear panel of the unit ② before plugging in.

If your mains supply voltage or mains plug is different, please consult your Arcam dealer immediately.

Plugging in

Push the IEC-plug of the power cable into the socket **POWER INLET** ① in the back of the unit, making sure it is pushed in firmly.

Stand-by power

For remote stand-by operation, the amplifier's control power-supply is kept powered up all the time the unit is connected to the mains supply. The front-panel power-switch powers all other circuitry down and power consumption in this mode is less than 2W.

This means that even though the power-switch is off, it may be possible to hear a slight residual hum coming from the mains transformer inside the amplifier. This is perfectly normal. If the unit is to be left unused for an extended period, however, we recommend that it is disconnected from the mains supply.

Using your C31 pre-amplifier

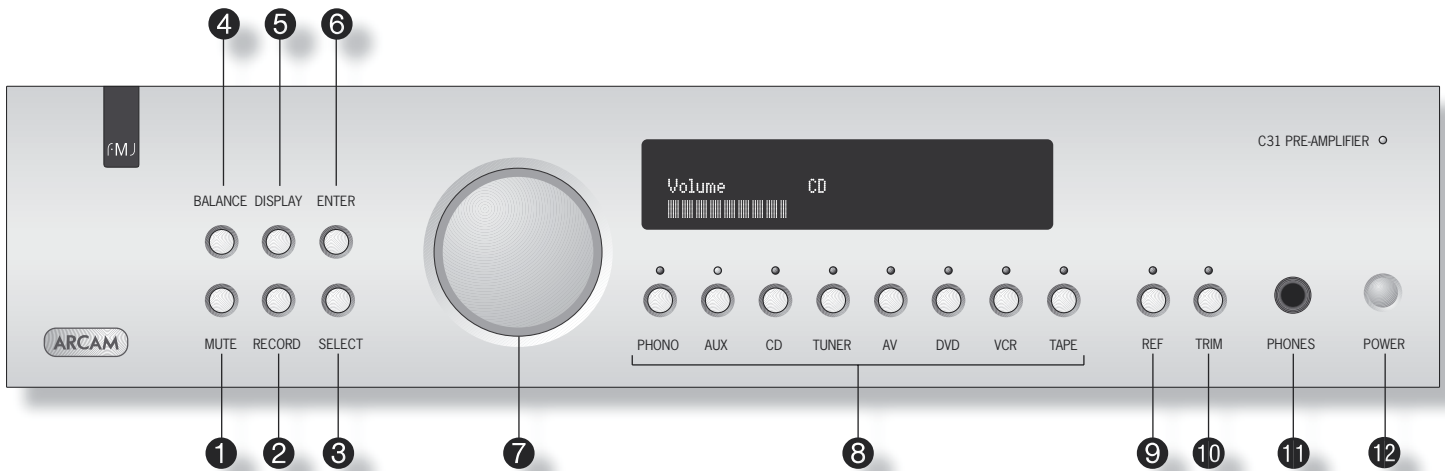

Switching the C31 on

The power button **12** switches the unit on and off; alternatively, the unit can be switched in and out of stand-by mode by pressing the **⊙** button on the remote control handset.

The power light (next to the "C31 Pre-Amplifier" text) indicates the state of the amplifier:

1. a red light means that the amplifier is in stand-by mode;
2. when you switch your amplifier on, the power light glows amber for a few seconds; during this time the outputs are muted;
3. the light changes to green when the amplifier is ready for use.

The power light may flash if a fault has occurred – the fault type is shown on the display. See page 16, "Troubleshooting," for help in resolving fault situations. If the fault cannot be cleared, unplug your amplifier and contact your Arcam dealer.

Changing the volume

Use the control knob **7** in the centre of the display to change the volume. Turn the knob clockwise to increase the volume, anti-clockwise to reduce it.

The output of the C31 can be muted by pressing **MUTE 1**. Press **MUTE** for a second time (or change the volume) to release the muting.

Selecting an audio source

A source-selection button **8** is used to select the source that is connected to the input corresponding to the button. A light above the relevant button indicates which input is selected and this information will also be shown on the display.

TAPE

To listen to the device connected to the tape input, press the **TAPE** button.

Note that two source lights will be illuminated when the **TAPE** button is pressed: the tape light itself, together with an indicator to show which source is being routed to the tape outputs for recording purposes. To change this recording source, please see below.

To de-select the tape input, press the **TAPE** button for a second time.



It is important to realise that the volume indication on the display may not be an accurate indication of the 'percentage' of the amplifier power in use. Your power amplifier may deliver its full power long before the volume control reaches its maximum position, particularly when listening to 'loud' inputs, such as CD's. In contrast, lower-level inputs, such as tuners and cassette decks, will sound quieter for the same shown volume level. To compensate for this (to make all inputs the same 'loudness' for a given value on the display), the input levels of each source may be adjusted. This is done using the product configuration menu, described on page 8.

Recording an audio source

The C31 allows listening to and recording from the same source, or listening to one source whilst recording another. The signal to be recorded is sent to both the **TAPE** and **VCR** output sockets.

Selecting the source for recording

The recording outputs can be configured in two ways:

1. to allow recording of the source being listened to;
2. to allow recording of a particular (specified) source, regardless of what is being listened to.

To record the source being listened to, press the **RECORD** button ② repeatedly until the display shows 'Record source'. After a few seconds the display reverts to showing the volume level, and you are ready to record.

In this configuration, selecting a different input changes the source that is routed to the recording outputs.

To record one source whilst listening to another, press **RECORD** again until the display shows 'Record' followed by the name of an input (e.g., 'Aux', 'CD', 'Tuner', etc.). Now press the source-selector button on the front-panel for the source you wish to record. Your selection is shown on the display for a few seconds, after which the display reverts to showing the volume level. You are now ready to record. Pressing a different source-selection button changes the source that you are listening to, but does not alter the source that is routed to the recording outputs.

Tape-to-tape copying (dubbing)

You can perform tape dubbing from **VCR** to **TAPE**, but not from **TAPE** to **VCR**.

For example, to copy from a cassette recorder connected to the VCR socket to a cassette recorder connected to the **TAPE** socket, first use the **RECORD** button as explained above and select 'Record VCR'. This routes the VCR signal to the **TAPE** output.

Listening using headphones

The headphone socket ⑩ accepts headphones with an impedance rating between 8Ω and 2kΩ, fitted with a 6.5mm stereo jack plug. The pre-amp. outputs are muted when headphones are plugged in.

The headphone socket is always active, unless the volume has been muted.



Did you know: the original 6.5mm (or 1/4") head-phone jack, dates from 1878 for use in manual telephone exchanges – making it possibly the oldest electrical connector standard on earth

Source: en.wikipedia.org

Product configuration

The C31 has a configuration menu that allows various performance and behaviour aspects to be altered. This menu is described in detail on the next page. Buttons have been provided on the front-panel to allow direct access to the most important configuration menu items:

- ④ **BALANCE** - gives direct access to the "Balance" menu item.
- ⑤ **DISPLAY** - this changes the display brightness. There are three brightness levels to choose from: 'on', 'dimmed' and 'off'. If the C31 is switched off while the display is set to 'off', the display will be set to 'dimmed' when the C31 is switched on again.
- ⑨ **REF** - this toggles the volume display mode between 'Standard', 'Fine', and 'Reference' (these are described on the next page. When the 'Reference' volume display is selected, the light above the Ref button is illuminated.
- ⑩ **TRIM** - gives direct access to the "Trim" menu item.

Configuring your C31 pre-amplifier

Introduction

The C31 allows you to customise various features of the amplifier to fit your system. Use this diagram to help you navigate through the available configuration options.

In the diagram below, the **ENTER** and **SELECT** buttons from the front panel are represented by the symbols **E** and **S** respectively.

The control knob is shown as **C**.

Adjusting listening settings

Normally, the display shows the current volume and the control knob is used to adjust this.

Press **SELECT** once to enter the configuration menu, then press it repeatedly to cycle through the menu items. When you have found the setting that you wish to adjust (the setting is shown on the display), it can be adjusted by using the control knob. Press **ENTER** to store the change you have made and return to default (volume) mode, or press **SELECT** again to move to the next setting.

Note that the menu will time-out after a short period of inactivity, with the display reverting to the current volume.

The following items are available for adjustment:

Volume Resolution – There are three volume-display options to choose from: 'Standard', 'Fine' or 'Reference'. Standard and Fine represent different levels of volume-control sensitivity; the Reference setting gives absolute increments in 0.5dB steps.

Input Trims – Input trims are used to compensate for variations in output levels of different source equipment. If, for example, your CD player is louder at a given volume display value than other inputs, you can attenuate it by using this setting so that it matches your other components.

Use the source-select buttons to select the input you wish to adjust, then the control knob to set (increase or decrease) the input volume for that source.

Max. 'On' Volume – This can be used to limit the maximum volume the amplifier operates at when it is first switched on: the C31 comes on at the (reduced) "Max. On Volume" level if the last-used volume exceeds this value.

If this item is set to 'Disabled', the C31 always comes on at the last used volume, even if this is very loud.

Processor Mode – Processor mode enables you to fix the gain (volume setting) of your C31. The C31 (in combination with a power amp.) can then be used to drive the front left and right speakers of a surround-sound system, when fed from a separate processor. The volume of the entire system can then be controlled using the processor.

Feed the sound from the processor into the **TAPE** input, then set the gain of the C31 to match the amplifiers that drive your other loudspeakers.

Reset – this restores all amplifier settings to their factory defaults.

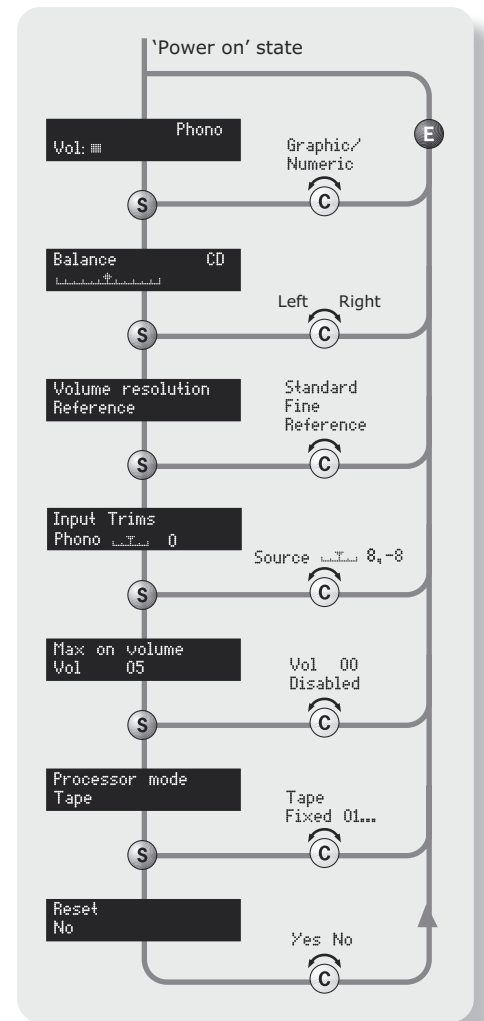

Using the remote control

CR-389 Remote Control

The CR-389 remote control gives access to all functions available on the front panel of the C31. It also has controls to operate Arcam CD players and tuners.

TUNER

These buttons are used to control Arcam tuner functions.

Note that the **FM/DAB** lights indicate into which mode you are switching the remote control. The lights only illuminate for five seconds to conserve battery power. If neither light is illuminated this does **not** mean that the remote control is not working.

▲ ▼ (UP and DOWN)

These buttons are used in the configuration menu and have the same effect as turning the control knob. Pressing **▲** is the same as turning the control knob clockwise, **▼** is the same as turning the knob anticlockwise.

ENTER

Performs the same function as the **ENTER** button on the front panel (see page 8).

SEL (Select)

Performs same function as the **SELECT** button on the front panel. It allows you to use the remote's volume switch in the same way you use the control dial on the front panel – to adjust various amplifier settings (see page 8).

Pressing + corresponds to turning the control knob clockwise, – to anticlockwise.

Source selection buttons

These operate in the same way as the source selectors on the front panel of your C31.



Power/Stand-by

Toggles the C31 between stand-by mode and full power mode. The power indicator light on the front panel is red if the C31 is in stand-by, amber while it is powering-up (this takes only a few seconds) and green when the C31 is operational.

SP1 and SP2



These buttons are for use with the P35 amplifier, to allow you to select and deselect the main (**SP1**) and secondary (**SP2**) sets of speakers attached to it (see page 14 for further information).

DISP (display)

Cycles through the settings 'Off', 'Dimmed' and 'Bright'. Turning the display 'Off' may give a slight improvement in sound quality.

Volume and (mute)

Press + to increase volume or – to decrease the output volume of the amplifier.

Press  to mute the pre-amp outputs of the C31. Note that both recording outputs will remain active. Mute is disabled by either pressing  again, or adjusting the volume.

CD controls

These offer basic control of Arcam CD players.



If you wish to use the same remote control for both your C31 and your DT91 tuner, please use the CR-389D remote control shipped with the tuner (instead of the remote control described here)

NOTE: Remember to install the two AAA batteries supplied before trying to use your remote control.

Do not place anything in front of the FMJ badge on the top left of the C31 (where the IR receiver is located), or the remote control may not work.

Installation: P35 and P1 power amplifiers

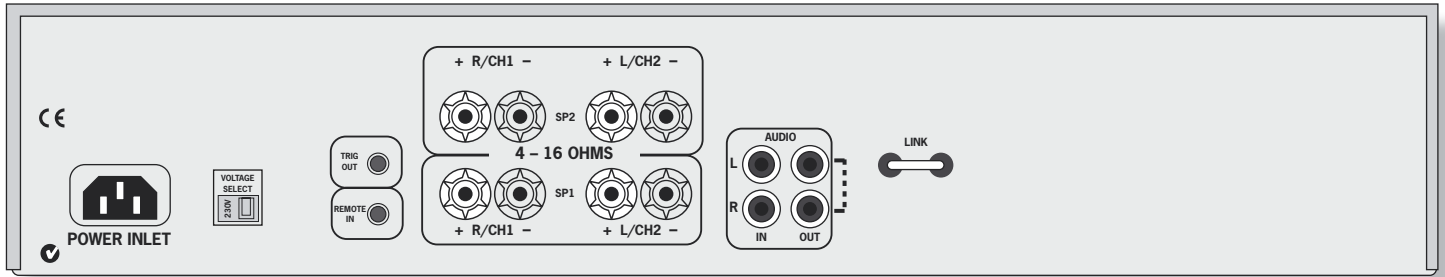

P35 Power Amplifier: rear panel

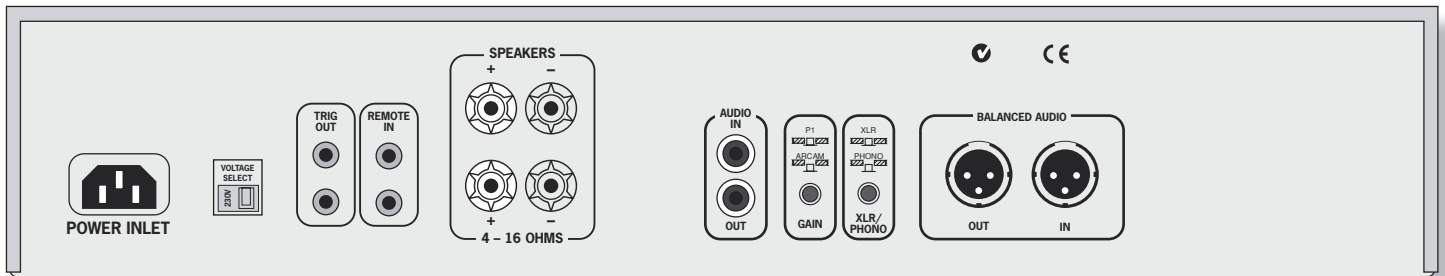

P1 Power Amplifier: rear panel

Positioning your power amplifier

- Place your amplifier on a firm, level surface.
- Avoid placing the unit in direct sunlight or near sources of heat or damp.
- Ensure adequate ventilation. Do not place the your amplifier in an enclosed space, such as a bookcase or cabinet, as both of these will impede air-flow through the unit (which is necessary for cooling).

In most situations, there are two choices for getting signals from the P35 to the speakers: the P35 can be situated remotely from the speakers and longer speaker cables used, or the P35 can be situated locally to the speakers by using longer line-level cables (from the pre-amplifier). Over long distances (5m+), the sound quality will generally be better using the low-current line-level (pre-amplifier) cabling than high-current speaker (post-amplifier) cabling, due to otherwise high losses in the speaker cabling.

Connecting to other equipment

The P35 and P1 amplifiers provide the following connections:

AUDIO IN (P35)

AUDIO IN and BALANCED AUDIO IN (P1)

Connect the output sockets of your pre-amp. (or the **PRE OUT** sockets of an integrated amplifier) to one of these inputs. Please read the information on page 5 "Power-amplifier connections", which details the type of connection that should be used.

Mono Link (P35)

The P35 can be adapted to provide two mono loudspeaker outputs from a single input. Pull out the link supplied on the back panel (labelled 'link') and use it to connect the **L** and **R AUDIO OUT** sockets together. Using one power amplifier per loudspeaker will enable you to bi-amplify bi-wireable loudspeakers (as described on the following page).

Follow the instructions given below for bi-wiring, using the **SP2** connections of the P35 for the high-frequency speaker and the **SP1** connections for the low-frequencies. See also the section on "Remote switching".

Input Selector Switch (P1)

This switch allows either unbalanced signals (through the phono connector) or balanced signals (through the XLR connector) to be selected. The switch should be pressed-in to select the phono inputs and out to select the XLR connector. Note that only one type of input connector will be switched to the input of the amplifier; if you select (for example) the XLR connector, then you will not be able to hear signals connected to the phono inputs.

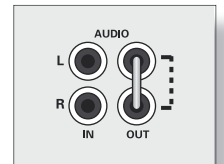

The mono link fitted

Amplifier Gain Switch (P1)

This switch is to allow the gain of the P1 amplifier to be changed to suit your system requirements.

With the switch in, the gain is set to standard ARCAM gain of 31.5dB. This is the normal setting, which allows the P1 to be used in systems where there are other ARCAM power amplifiers (excluding the Arcam P7).

With the switch out, the gain is set to 'THX standard gain'. Use this setting if your P1 is to be used in systems containing amplifiers with THX gain (for example, the Arcam P7).

Daisy chaining

Both the P35 and the P1 can be connected to further power amplifiers to drive more speakers (e.g., those in other rooms, tri-amplified speakers, etc). This technique is called 'Daisy chaining'.

Connect the **AUDIO OUT** sockets on the P35/P1 to the pre-amp. input of the next amplifier in series, left to left, right to right.

Remote switching

By making a connection from the **TRIG OUT** socket of the C31 pre-amp. to the **REMOTE IN** socket of your P35/P1, you can use the C31 to switch the power amplifier on and off. If configured in this way, the front panel **POWER** button of the C31 (or the **POWER** button on the remote control) switches both amplifiers on and off together. This facility allows you to position your power amplifier in a remote location (such as close to the speaker it is amplifying), yet still control it.

The connecting cable to use is a 3.5mm jack lead, wired as given on page 5. It is possible to connect several power amplifiers to a C31 by 'daisy chaining' from the **TRIG OUT** of one power amplifier into the **REMOTE IN** of the next.

Connecting loudspeakers

Wiring strategies

There are three different wiring strategies that can be employed to connect your amplifier to your speakers. The choice will be limited by what your speakers can support.

■ Single wiring

Single wiring is the conventional wiring method of running a single cable per channel between the amplifier and the speaker. This is the easiest technique.

■ Bi-wiring

Bi-wiring is running two separate cables between the amplifier and each speaker, with one cable carrying the low-frequency information, the other the higher-frequency signals. The P35 and P1 are designed to allow easy bi-wiring, but speakers support it only if separate connection terminals are provided for the two cables (the speaker will have two pairs of terminals on the back, one pair labelled 'HF' or 'High Frequency', the other pair labelled 'LF' or 'Low Frequency').

Why is this useful?

Bi-wiring improves the sound of your system because the separation of high- and low-frequency signal currents into separate speaker cables avoids distortions caused by the different currents interacting with one-another within a single cable, as occurs in single-wired systems.

■ Bi-amping

Bi-amping is the separation of the amplification of low- and high-frequency signals over two amplifiers. You will require two amplifiers to do this.

Why is this useful?

The performance of your system is enhanced over bi-wiring by extending the signal separation principle to use separate amplification for the low and high frequency drivers in each speaker.

Single wiring

Both the P35 and the P1 are designed for bi-wiring, which is why there are duplicate speaker terminals on the back. Both amps are quite happy with single-wiring, however; we recommend that you use the lower sets of speaker terminals (labelled 'SP1' on the P35) in this case. Similarly, if your speaker has more than one pair of connecting terminals, use the terminals labelled 'LF' or 'Low Frequency' on the speaker.

For the P35, connect the positive terminal of the right speaker connection on the amplifier (coloured red and labelled '+R') to the positive terminal of your right speaker. Similarly, connect the negative terminal of the amplifier (coloured black and labelled 'R-') to the negative terminal of your speaker. Repeat the process for the left speaker, using the amplifier terminals labelled '+L-'.
For the P1, connect the positive speaker terminal (coloured red and labelled '+') to the positive terminal of the speaker to be driven. Similarly, connect the negative terminal of the amplifier (coloured black and labelled '-') to the negative terminal of the same speaker. Repeat the process for your other P1 and speaker.

If your speakers support bi-wiring, then there is a strip of metal on the speakers connecting the low-frequency terminals to those for the higher-frequencies; this must **not** be removed in a single-wired system.

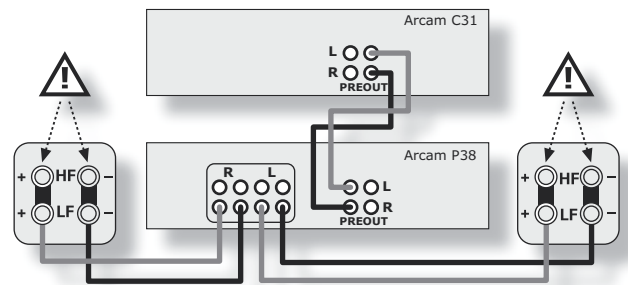

A P35 connected to speakers using single wiring.

Bi-wiring

Bi-wiring is performed in the same way as single wiring except that, for each speaker, a **pair** of cables are used to connect the amplifier to each speaker.

Follow the instructions given for single wiring; then perform the same actions, this time connecting the second set of speaker terminals (labelled "SP2" on the P35) to the speaker terminals labelled 'HF' or 'High Frequency'. Please refer to the illustration.

Speakers that support bi-wiring have a strip of metal on the speakers connecting the low-frequency terminals to those for the higher-frequencies; this must be **removed** in a bi-wired system.

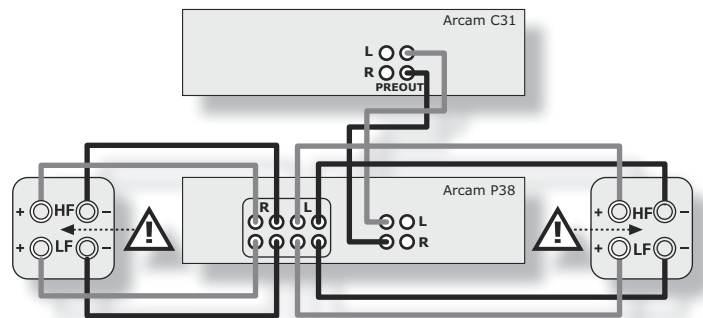

A P35 connected to speakers using bi-wiring.

Bi-amping

Bi-amping requires the use of a two amplifiers per channel: either two P35's or four P1's in a stereo system. One P35 (or two P1's) is/are used to drive the high-frequency (treble) speakers, the other is used for the lower (bass) frequencies.

For the P35's, connect one P35 to the speakers as described for single wiring, with the exception that the P35 should be connected to the speaker terminals labelled 'HF' or 'High Frequency'. Then (in the same way), connect the second P35 to the low-frequency terminals. Please refer to the illustration.

For the P1's: four P1 amplifiers are required for bi-amping two speakers. Two of the P1's are used to drive high-frequency (treble) and two are used for the lower (bass) frequencies. Decide which amplifier is to drive which speaker element, then connect the amplifier to the speaker following the instructions given for single wiring.

Note that the strip of metal on the speakers connecting the lower terminals to the upper terminals **must be removed**. Failure to do so will result in damage to both amplifiers, which will not normally be covered under warranty.

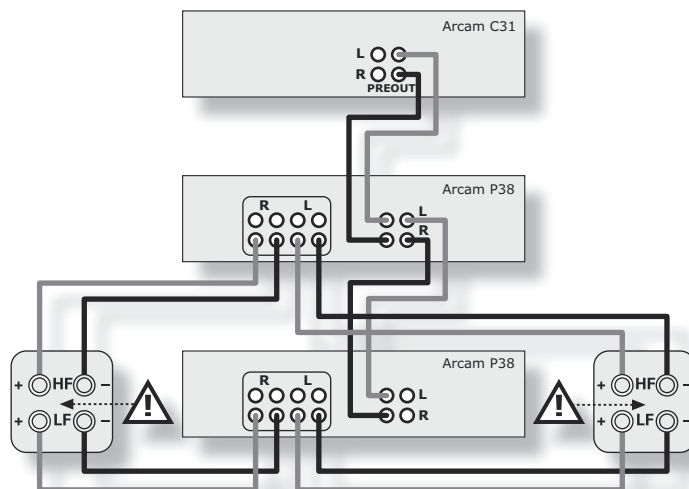

A P35 connected to speakers using bi-amping.

Notes on making speaker connections

- Do not make any connections to any amplifier while it is switched on. We recommend that your amplifier is completely disconnected from the mains supply before starting.
- Before switching your amplifier(s) on for the first time after connecting to speakers, please check all connections thoroughly. Ensure that bare wires or cables are not touching each other or the amplifier's chassis (which could cause short circuits), and that you have connected positive (+) to positive and negative (-) to negative. Be sure to check the wiring for both the amplifier **and** the speaker.
- After making connections: switch the amplifier(s) on, select a source signal, then gradually increase the volume to the required listening level.
- If you are unsure as to how your system should be connected, or need advice on bi-wiring or bi-amping, please contact your Arcam dealer who will be happy to help you.

Connecting to a power supply

Mains lead

Your amplifier is normally supplied with a moulded mains plug already fitted to the lead. Check that the plug fits your supply and that your mains supply voltage agrees with the voltage setting (115V or 230V) indicated on the rear panel of the unit before plugging in.

If your mains supply voltage or mains plug is different, please consult your Arcam dealer immediately.

Plugging in

Push the IEC-plug of the power cable into the socket **POWER INLET** on the back of the unit, making sure it is pushed in firmly.

Stand-by power

For remote stand-by operation, the amplifier's control power supply is kept powered-up all the time the unit is connected to the mains supply. The front-panel power-switch powers down all other circuitry and power consumption in this mode is less than 2W.

This means that even though the power switch is off, it may be possible to hear a slight residual hum coming from the mains transformer inside the amplifier. This is perfectly normal. If the unit is to be left unused for an extended period, however, we recommend that it is disconnected from the mains supply.

Using your power amplifier

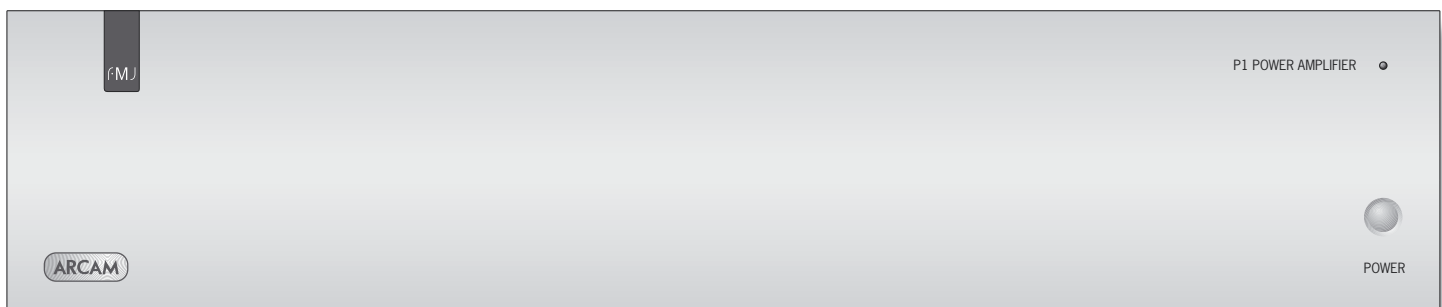
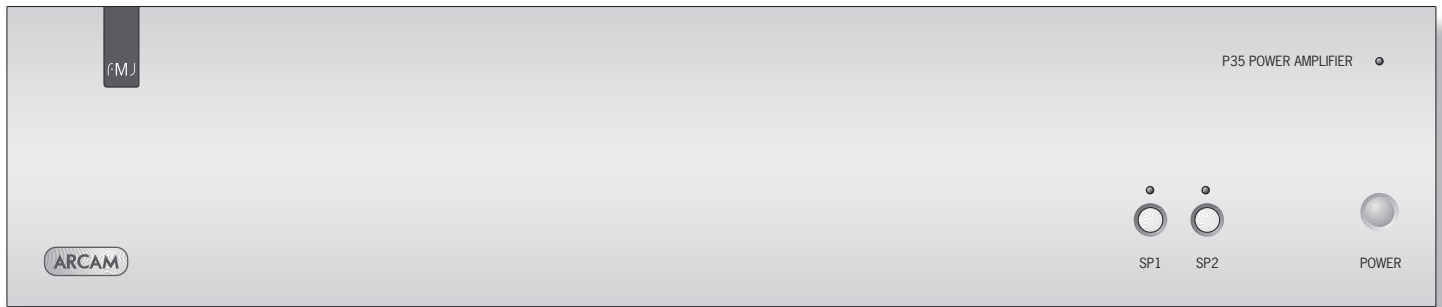

P1 Power Amplifier: Front panel

POWER button

Switches the unit on and off. The light indicates the status of the amplifier.

When you switch your amplifier on, the light glows amber for a few seconds, during which time the speakers are disconnected. The light changes to green when the amplifier is ready for use. A red light means the amplifier is in stand-by mode.

The power light may flash if a fault has occurred, with the colour of the flashing light indicating the nature of the fault:

- green – a D.C. offset fault has occurred (see info. box);
- amber – a thermal fault has occurred (the amplifier is too hot). Ensure that your amplifier has adequate ventilation;
- red – a short-circuit fault has occurred. This can happen if the speaker cables are not connected correctly and are making contact with each other or with the chassis;
- red and amber – more than one fault has occurred.

Except for a thermal fault, if one of the above faults is detected by your amplifier the unit waits for six seconds before checking to see if the fault has cleared. If the fault clears within six seconds, the unit continues operation; otherwise the unit shuts itself down. In the case of a thermal fault, the unit waits until its sensor temperature lowers before resuming operation.

If the amplifier has shut itself down, you should unplug the amplifier and leave it for a few minutes before reconnecting. If the fault cannot be cleared in this way, unplug your amplifier and contact your Arcam dealer.

SP1 and SP2 (P35 only)

These buttons allow you to select and deselect the main (SP1) and secondary (SP2) sets of speakers attached to your amplifier. An indicator light shows which set of speakers are currently selected.

Note that if both lights are out then the amplifier will appear not to work, as all speakers are switched off.



A "DC offset fault" is not an amplifier fault, but a speaker protection mechanism. If the amplifier is supplied with a DC voltage (rather than the expected AC voltage) for an extended length of time, the coils in the attached speakers will eventually burn out (or, in extreme cases, catch fire). Your Arcam amplifier can detect this condition, and cut the current to the speakers.

DC offset faults can occur intermittently in all set-ups, particularly if a tuner or satellite receiver is connected. If it occurs frequently or predictably, please contact your dealer for advice.

Technical specifications

	C31	P35	P1
Continuous power output (20Hz–20kHz at 0.5% THD), per channel			
Both channels, 8Ω, 20Hz–20kHz		100W	
Single channel, 8Ω, 20Hz–20kHz		150W	170W
Both channels, 4Ω, 20Hz–20kHz		140W	
Single channel, 4Ω, at 1kHz		200W	250W
Three channels, 8Ω, 20Hz–20kHz		90W	
Harmonic distortion, 80% power, 8Ω at 1kHz		0.005%	0.003%
Inputs			
Phono cartridge:			
Input sensitivity	2.7mV (MM); 270μV (MC)		
Input impedance	47kΩ (MM); 300Ω (MC)		
Signal/noise ratio (CCIR)	–79dB (MM); –73dB (MC)		
Overload margin	35dB		
Line and tape inputs:			
Nominal sensitivity	250mV–2V	800mV	
Input impedance	22kΩ	22kΩ	
Signal/noise ratio (CCIR)	–113dB	–110dB	
Power amplifier input			
Nominal sensitivity		800mV	906mV (Arcam gain)
Input impedance		22kΩ	22kΩ
Gain		31.5dB	31.5dB (Arcam gain)
Preamplifier output			
Nominal output level	700mV		
Maximum output level	8V RMS		
Output impedance	<50Ω		
Headphone output			
Maximum output level into 600Ω	5V		
Output impedance	4.7Ω		
General			
Mains voltage	115V or 230V	115V or 230V	115V or 230V
Power consumption (maximum)	30VA	800VA (950VA for P35/3)	800VA
Power consumption (standby)	2VA	2VA	2VA
Dimensions W x D x H (including feet)	430 x 370 x 110mm	430 x 350 x 110mm	430 x 350 x 110mm
Weight (net)	9.3kg	9.5kg (10.5kg for P35/3)	12.5kg
Weight (packed)	11.5kg	12.5kg (13.5kg for P35/3)	15.5kg
Supplied accessories	mains lead CR-389 remote control 2 x AAA batteries	mains lead	mains lead
E&OE			

NOTE: All specification values are typical unless otherwise stated.

Continual improvement policy

Arcam has a policy of continual improvement for its products. This means that designs and specifications are subject to change without notice.

Remote-control codes

The following tables give the IR-commands accepted by the C31.

Power commands

Command	Decimal Code
Power toggle	16-12
Power-on	16-123
Power-off	16-124

Source selection commands

Command	Decimal Code
PHONO select	16-1
AV select	16-2
TUNER select	16-3
DVD select	16-4
TAPE select	16-5
VCR select	16-6
CD select	16-7
AUX select	16-8

Menu navigation commands

Command	Decimal Code
UP	16-32
DOWN	16-33
SELECT	16-37
ENTER	16-87

Display control commands

Command	Decimal Code
Display	16-59

Volume control commands

Command	Decimal Code
Mute	16-13
Volume up	16-16
Volume down	16-17

The following tables give commands accepted by the P35.

Power commands

Command	Decimal Code
Power toggle	16-12
Power-on	16-123
Power-off	16-124

Speaker control commands

Command	Decimal Code
Speaker 1 toggle	16-35
Speaker 2 toggle	16-39
Speaker 1 on	16-43
Speaker 1 off	16-44
Speaker 2 on	16-45
Speaker 2 off	16-46

The following table gives commands accepted by the P1.

Power commands

Command	Decimal Code
Power toggle	16-12
Power-on	16-123
Power-off	16-124

Note that the C31 also responds to code 20-53 (the **PLAY** command for an Arcam CD player). The C31 switches automatically to CD input on receiving this command.

Troubleshooting

If you are having trouble with your amplifier, check the following items.

No sound

Check the following:

- Both the pre- and power-amplifiers are switched on.
- The pre-amp. is not muted (indicated on the C31 by "Muted" being shown on the front-panel).
- The selected source is generating audio (e.g., if CD is selected, then the CD is playing).
- The tape input is not selected on the C31 (indicated by the light above the **TAPE** button being illuminated), instead of the expected source. In this case, press **TAPE** again to de-select the tape input.
- The speaker outputs are enabled on the P35, as indicated by the lights above the **SP1** and/or **SP2** buttons (as appropriate) being illuminated.

Sound cuts-out unexpectedly

If the temperature of the internal heatsink rises above a safe level, then a thermal cut-out inside the amplifier will operate. During this time, the power indicator on the front panel flashes and the protection system temporarily removes the power to the speakers. The system will reset itself as the heatsink cools down.

- With two pairs of low-impedance speakers connected (6Ω or less), overloads are more likely. Overloading the amplifier may cause it to shut down because of overheating.
- Note that, due to the high output voltage from a CD player, it is possible to drive your amplifier at full power even though the volume is not set at maximum. See page 6.

Amplifier does not switch back on

All the amplifiers detailed in this handbook have a protection mechanism which is activated if you switch the unit on immediately after turning it off. If this mechanism activates, wait 30 seconds then try again to switch the unit on.

Guarantee

Worldwide Guarantee

This entitles you to have the unit repaired free of charge, during the first two years after purchase, at any authorised Arcam distributor provided that it was originally purchased from an authorised Arcam dealer or distributor. This period can be extended to five years if the completed registration card is returned to Arcam. Arcam can take no responsibility for defects arising from accident, misuse, abuse, wear and tear, neglect or through unauthorised adjustment and/or repair, neither can they accept responsibility for damage or loss occurring during transit to or from the person claiming under the guarantee.

The warranty covers parts and labour costs for two years from the purchase date (five years upon registration). After this time you must pay for both parts and labour costs. **The warranty does not cover transportation costs at any time.**

Claims under guarantee

This equipment should be packed in the original packing and returned to the dealer from whom it was purchased, or failing this, directly to the Arcam distributor in the country of residence. It should be sent carriage prepaid by a reputable carrier – **not** by post. No responsibility can be accepted for the unit whilst in transit to the dealer or distributor and customers are therefore advised to insure the unit against loss or damage whilst in transit.

For further details contact Arcam at:

Arcam Customer Support Department,
Pembroke Avenue, Waterbeach, CAMBRIDGE, CB5 9QR, England.

Problems?

Always contact your dealer in the first instance.

If your dealer is unable to answer any query regarding this or any other Arcam product please contact Arcam Customer Support at the above address and we will do our best to help you.

On-line registration

You can register your Arcam product on-line at: www.arcam.co.uk.

ARCAM

PEMBROKE AVENUE, WATERBEACH, CAMBRIDGE CB5 9QR, ENGLAND
www.arcam.co.uk